

# GUMIJAS PROFILI

Preces artikuls	Nosaukums	Mērvienība	Materiāls
47300359	Malas aizsargs(mazais)	m	PVC/CS
47300360	Malas aizsargs(lielais)	m	PVC/CS
47300900	Malas aizsargs (EPDM)	m	EPDM/CS
47300401	Malas aizsargs PVC/ST(14,5x10)	m	PVC/ST

**Lielais**

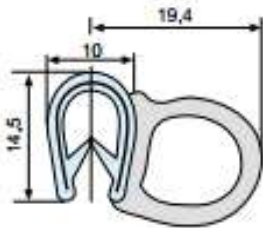

**Mazais**

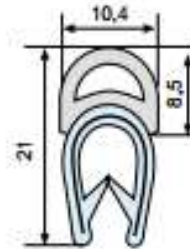

**EPDM/CS**

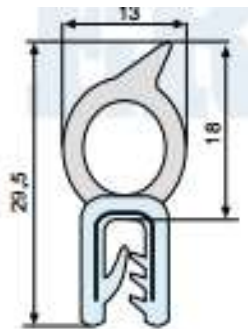

**PVC/ST**

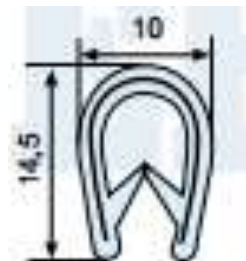

# GUMIJAS PROFILI

Preces artikuls	Nosaukums	Mērvienība	Materiāls
47300244	Profils T veida(lielais)	m	EPDM
47300259	Profils T veida(mazais)	m	EPDM

**Lielais**

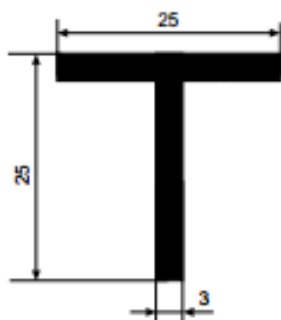

**Mazais**

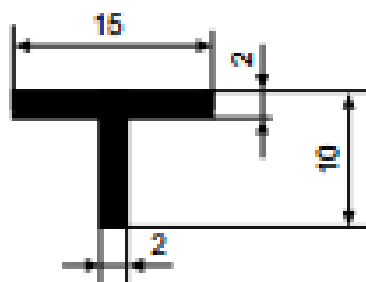

# GUMIJAS PROFILI

Preces artikuls	Nosaukums	Mērvienība	Materiāls
47300203	U veida(balts)	m	EPDM
47300207	U veida	m	EPDM
47300219	U veida(8x12)	m	EPDM
47300122	U veida	m	Neopreen

**Baltais**

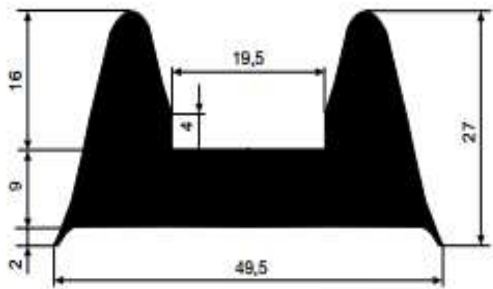

**U veida**



**U veida (8x12)**

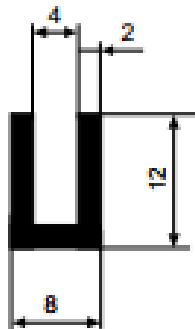

**U veida(neopreen)**

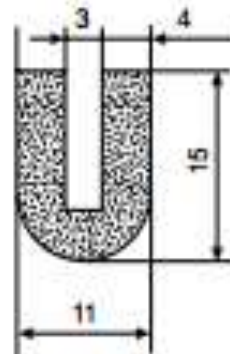

# GUMIJAS PROFILI

Preces artikuls	Nosaukums	Mērvienība	Materiāls
47300237	P1 veida	m	EPDM
473001	P2 veida(3metri)	m	EPDM

## P1 veida

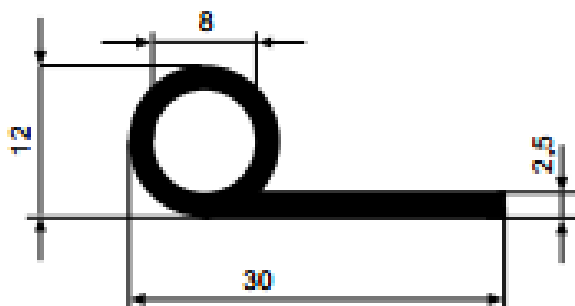

## P2 veida(3metri)

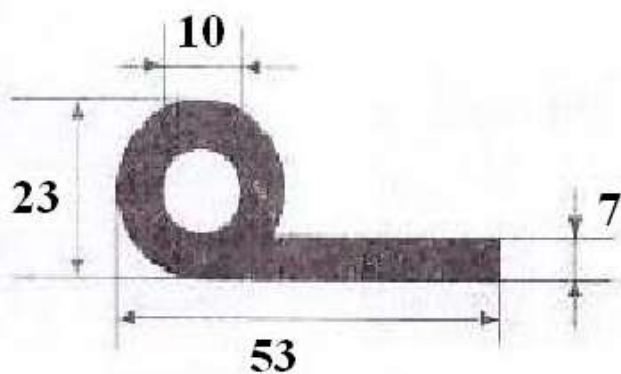

# GUMIJAS PROFILI

Preces artikuls	Nosaukums	Mērvienība	Materiāls
47300260	Moldings	m	EPDM

## Moldings

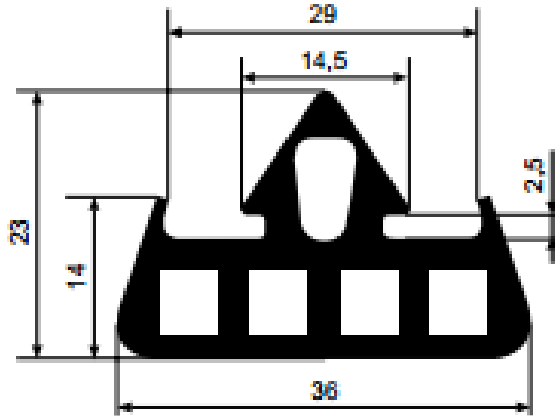

Preces artikuls	Nosaukums	Mērvienība	Materiāls
47300251	Malas aizsargs (e)	m	EPDM

## Malas aizsargs-profils (e)

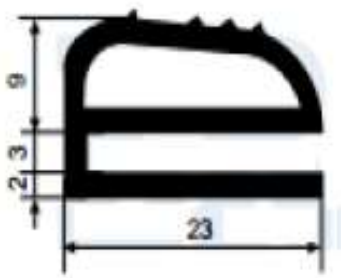

# GUMIJAS PROFILI

Preces artikuls	Nosaukums	Mērvienība	Materiāls
47300146	Profils CR	m	gumija

## Profils CR

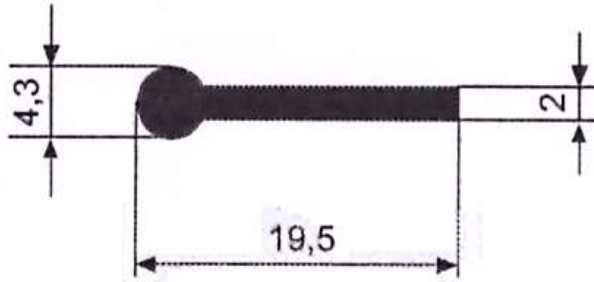

Preces artikuls	Nosaukums	Mērvienība	Materiāls
470115	10x10 Kvadrāts	kg	gumija
470116	10x10 Profils	kg	gumija
470117	10x12 Kvadrāts	kg	gumija

## Kvadrāts



## Kvadrāts 10x12



# GUMIJAS PROFILI

Preces artikuls	Nosaukums	Mērvienība	Materiāls
47300077	Taisnstūrveida 12x8	m	Porains

## Taisnstūrveida



Preces artikuls	Nosaukums	Mērvienība	Materiāls
47222020	20x20	m	Porains

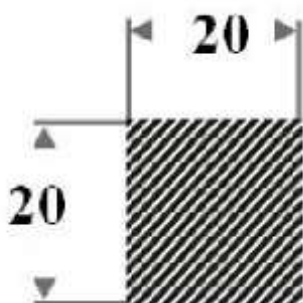

# GUMIJAS PROFILI

Preces artikuls	Nosaukums	Mērvienība	Materiāls
90025	N-1 mazais	m	gumija
90026	N-2 ķīlis	m	gumija
90027	N-3 lielais	m	gumija

